

LEGEND

- COMBUSTION AIR
- FRESH AIR
- FLUE GAS
- STEAM
- LP NATURAL GAS
- NO. 2 FUEL OIL
- COMPRESSED AIR
- FEEDWATER

FCS Fossil Consulting Services, Inc.
Columbia, Maryland

SAMPLE FLOW DIAGRAM

BOILERS 1, 2, & 3

BOILER OVERVIEW

DATE	DRAWING NO.	REV.
12/13/2021	FD-BLR123-001	0

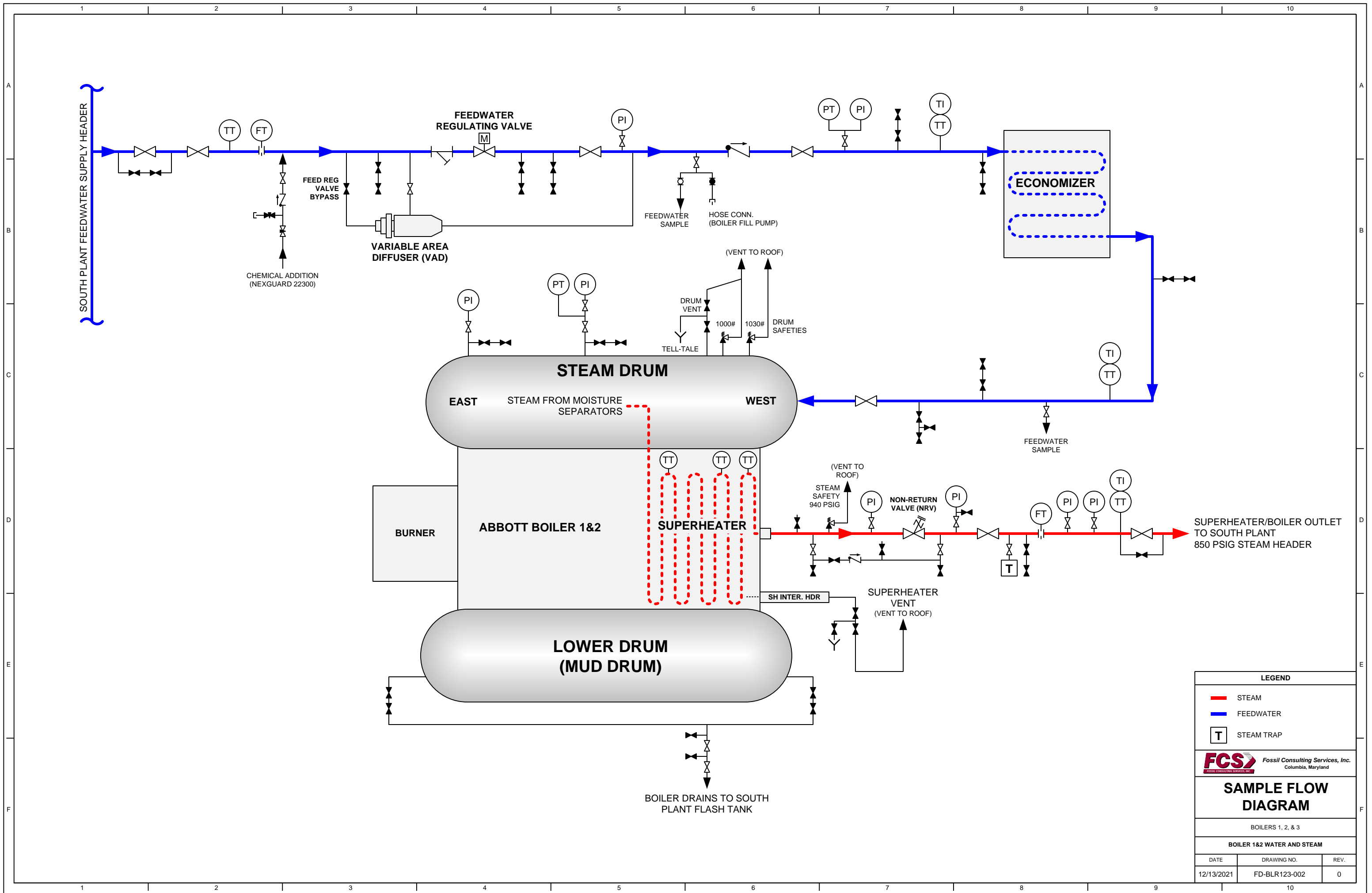

LEGEND		
—	STEAM	
—	FEEDWATER	
T	STEAM TRAP	
FCS Fossil Consulting Services, Inc. Columbia, Maryland		
SAMPLE FLOW DIAGRAM		
BOILERS 1, 2, & 3		
BOILER 1&2 WATER AND STEAM		
DATE	DRAWING NO.	REV.
12/13/2021	FD-BLR123-002	0

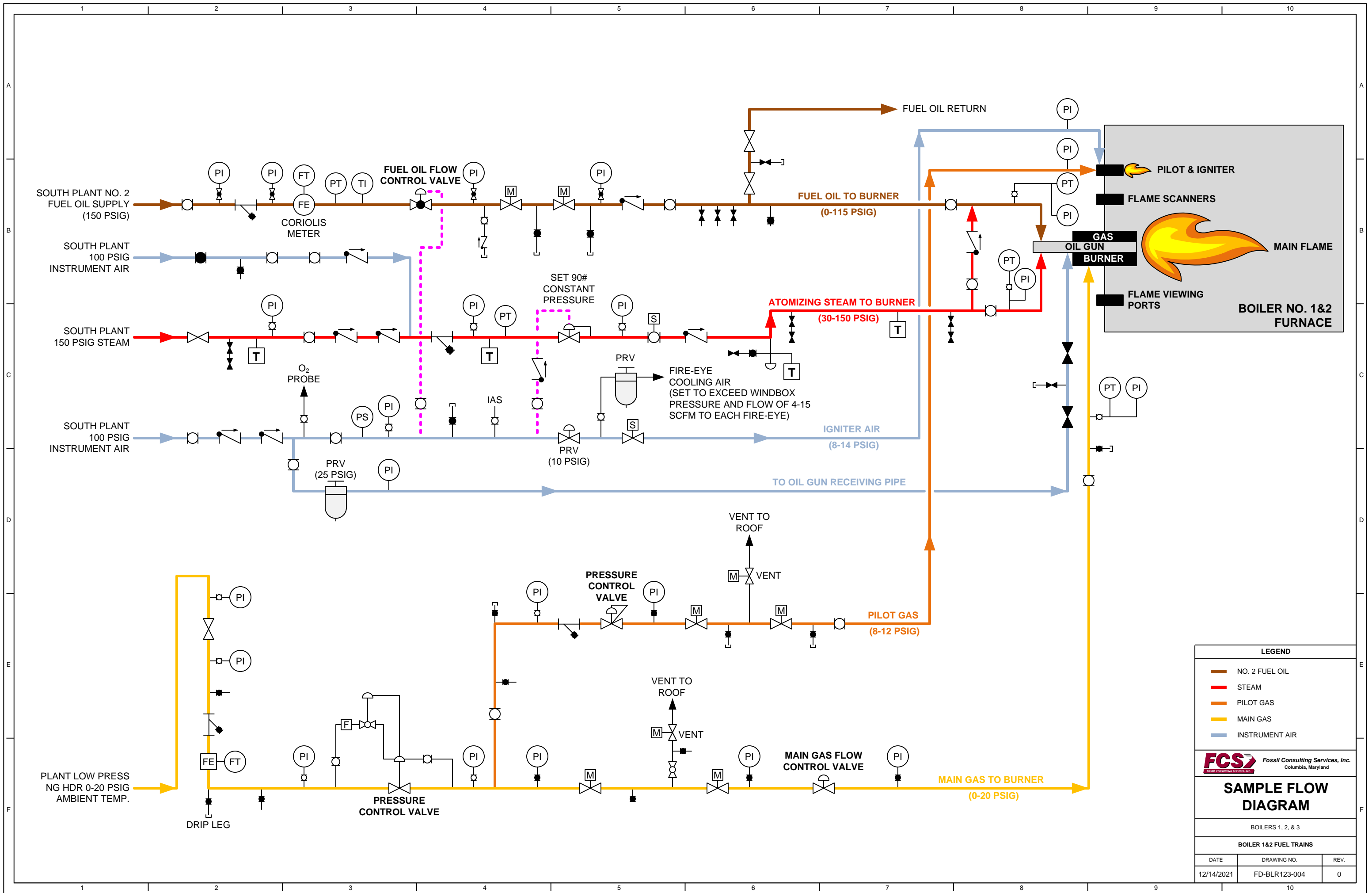

LEGEND

- NO. 2 FUEL OIL
- STEAM
- PILOT GAS
- MAIN GAS
- INSTRUMENT AIR

FCS Fossil Consulting Services, Inc.
Columbia, Maryland

SAMPLE FLOW DIAGRAM

BOILERS 1, 2, & 3

BOILER 1&2 FUEL TRAINS

DATE	DRAWING NO.	REV.
12/14/2021	FD-BLR123-004	0

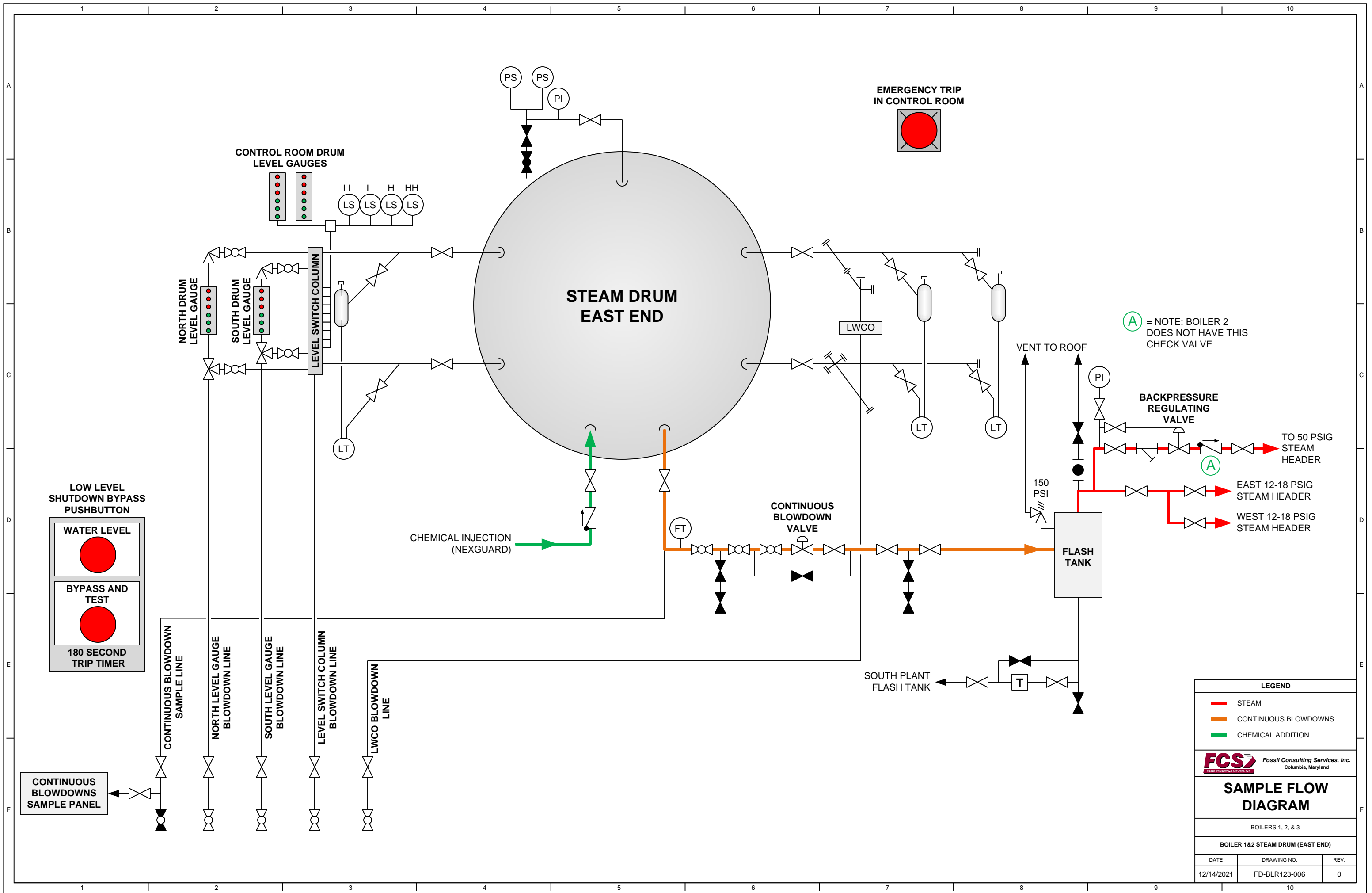

EMERGENCY TRIP
IN CONTROL ROOM

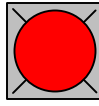

CONTROL ROOM DRUM
LEVEL GAUGES

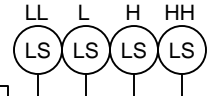

STEAM DRUM
EAST END

NORTH DRUM
LEVEL GAUGE

SOUTH DRUM
LEVEL GAUGE

LEVEL SWITCH COLUMN

LWCO

(A) = NOTE: BOILER 2
DOES NOT HAVE THIS
CHECK VALVE

VENT TO ROOF

BACKPRESSURE
REGULATING
VALVE

TO 50 PSIG
STEAM
HEADER

EAST 12-18 PSIG
STEAM HEADER

WEST 12-18 PSIG
STEAM HEADER

CHEMICAL INJECTION
(NEXGUARD)

CONTINUOUS
BLOWDOWN
VALVE

FLASH TANK

150
PSI

SOUTH PLANT
FLASH TANK

LOW LEVEL
SHUTDOWN BYPASS
PUSHBUTTON

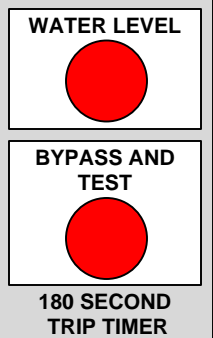

CONTINUOUS BLOWDOWN
SAMPLE LINE

NORTH LEVEL GAUGE
BLOWDOWN LINE

SOUTH LEVEL GAUGE
BLOWDOWN LINE

LEVEL SWITCH COLUMN
BLOWDOWN LINE

LWCO BLOWDOWN
LINE

CONTINUOUS
BLOWDOWNS
SAMPLE PANEL

LEGEND

- STEAM
- CONTINUOUS BLOWDOWNS
- CHEMICAL ADDITION

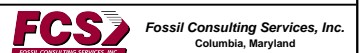

**SAMPLE FLOW
DIAGRAM**

BOILERS 1, 2, & 3

BOILER 1&2 STEAM DRUM (EAST END)

DATE	DRAWING NO.	REV.
12/14/2021	FD-BLR123-006	0